



## HUS3 Screw anchor

	Anchor version	Benefits
	HUS3-H 8 / 10 / 14 Carbon steel concrete screw with hexagonal head	- High productivity – less drilling and fewer operations than with conventional anchors - ETA approval for cracked and non-cracked concrete - ETA approval for adjustability (unscrew-rescrew)
	HUS3-C 8 / 10 Carbon steel concrete screw with countersunk head	- Seismic approval ETA C1 - High loads - Small edge and spacing distances - abZ (DIBt) approval for reusability in fresh concrete ( $f_{t,c,cube}=10/15/20$ Nmm <sup>2</sup> ) for temporary applications
	HUS3-HF 10 / 14 Carbon steel concrete screw with multilayer coating ( $\geq 14 \mu\text{m}$ ) and hexagonal head	- Three embedment depths for maximum design flexibility - HUS3-HF with multilayer coatings for additional corrosion protection



Concrete



Tensile zone

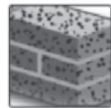

Solid brick

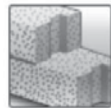

Autoclaved aerated concrete



Seismic ETA-C1

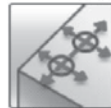

Small edge distance and spacing



Fire resistance



Sprinkler approved



European Technical Approval



CE conformity



DIBt Approval Reusability



PROFIS Anchor design software

### Approvals / certificates

Description	Authority / Laboratory	No. / date of issue
European technical assessment <sup>a)</sup>	DIBt, Berlin	ETA-13/1038 / 2014-09-19
DIBt approval (Reusability)	DIBt, Berlin	Z-21.8-2018 / 2014-04-01

a) All data given in this section for HUS3-H and HUS3-C according ETA-13/1038, issue 2014-09-19.

## Basic loading data (for a single anchor)

All data in this section applies to

For details see Simplified design method

- Correct setting (See setting instruction)
- No edge distance and spacing influence
- Steel failure
- Minimum base material thickness
- Cracked and non-cracked Concrete C 20/25,  $f_{ck,cube} = 25 \text{ N/mm}^2$
- Adjustment allowed during the installation for size 8 and 10, types H, C and  $h_{nom2}$  only.

### Mean ultimate resistance

		Data according ETA-13/1038, issue 2014-09-19.								
Anchor size		8			10			14		
Type	HUS3	H, C			H, C			H		
Nominal embedment depth	$h_{nom}$ [mm]	50	60	70	55	75	85	65	85	115
Non-cracked concrete										
Tensile $N_{Ru,m}$	[kN]	11,9	15,9	21,2	15,9	26,6	36,8	23,2	36,2	59,0
Shear $V_{Ru,m}$	[kN]	17,0	17,9	17,9	18,0	29,4	29,4	46,4	47,3	47,3
Cracked concrete										
Tensile $N_{Ru,m}$	[kN]	8,0	11,9	15,9	12,8	21,4	26,3	16,5	25,8	42,0
Shear $V_{Ru,m}$	[kN]	12,1	17,9	17,9	12,8	29,4	29,4	33,1	47,3	47,3
Hilti Tech. Data										
Anchor size		10			14					
Type	HUS3	HF			HF					
Nominal embedment depth	$h_{nom}$ [mm]	55	75	85	65	85				
Non-cracked concrete										
Tensile $N_{Ru,m}$	[kN]	15,9	26,6	36,8	23,2	36,2				
Shear $V_{Ru,m}$	[kN]	18,0	25,7	25,7	46,4	47,3				
Cracked concrete										
Tensile $N_{Ru,m}$	[kN]	12,8	21,4	26,3	16,5	25,8				
Shear $V_{Ru,m}$	[kN]	12,8	25,7	25,7	33,1	47,3				

### Characteristic resistance

		Data according ETA-13/1038, issue 2014-09-19.								
Anchor size		8			10			14		
Type	HUS3	H, C			H, C			H		
Nominal embedment depth	$h_{nom}$ [mm]	50	60	70	55	75	85	65	85	115
Non-cracked concrete										
Tensile $N_{RK}$	[kN]	9,0	12,0	16,0	12,0	20,0	27,8	17,5	27,3	44,4
Shear $V_{RK}$	[kN]	12,8	17,0	17,0	13,5	28,0	28,0	35,0	45,0	45,0
Cracked concrete										
Tensile $N_{RK}$	[kN]	6,0	9,0	12,0	9,7	16,1	19,8	12,5	19,4	31,7
Shear $V_{RK}$	[kN]	9,1	17,0	17,0	9,7	28,0	28,0	24,9	38,9	45,0
		Hilti Tech. Data								
Anchor size		10			14					
Type	HUS3	HF			HF					
Nominal embedment depth	$h_{nom}$ [mm]	55	75	85	65	85				
Non-cracked concrete										
Tensile $N_{RK}$	[kN]	12,0	20,0	27,8	17,5	27,3				
Shear $V_{RK}$	[kN]	13,5	24,5	24,5	35,0	45,0				
Cracked concrete										
Tensile $N_{RK}$	[kN]	9,7	16,1	19,8	12,5	19,4				
Shear $V_{RK}$	[kN]	9,7	24,5	24,5	24,9	38,9				

**Design resistance**

		Data according ETA-13/1038, issue 2014-09-19.								
Anchor size		8			10			14		
Type	HUS3	H, C			H, C			H		
Nominal embedment depth	$h_{nom}$ [mm]	50	60	70	55	75	85	65	85	115
Non-cracked concrete										
Tensile $N_{Rd}$	[kN]	6,0	8,0	10,7	8,0	13,3	18,5	11,7	18,2	29,6
Shear $V_{Rd}$	[kN]	8,5	11,3	11,3	9,0	18,7	18,7	23,3	30,0	30,0
Cracked concrete										
Tensile $N_{Rd}$	[kN]	4,0	6,0	8,0	6,4	10,8	13,2	8,3	13,0	21,1
Shear $V_{Rd}$	[kN]	6,1	11,3	11,3	6,4	18,7	18,7	16,6	25,9	30,0
		Hilti Tech. Data								
Anchor size		10			14					
Type	HUS3	HF			HF					
Nominal embedment depth	$h_{nom}$ [mm]	55	75	85	65	85				
Non-cracked concrete										
Tensile $N_{Rd}$	[kN]	8,0	13,3	18,5	11,7	18,2				
Shear $V_{Rd}$	[kN]	9,0	16,3	16,3	23,3	30,0				
Cracked concrete										
Tensile $N_{Rd}$	[kN]	6,4	10,8	13,2	8,3	13,0				
Shear $V_{Rd}$	[kN]	6,4	16,3	16,3	16,6	25,9				

## Recommended load

		Data according ETA-13/1038, 2014-09-19.								
Anchor size		8			10			14		
Type	HUS3	H, C			H, C			H		
Nominal embedment depth	$h_{nom}$ [mm]	50	60	70	55	75	85	65	85	115
Non-cracked concrete										
Tensile $N_{Rec}$	[kN]	4,3	5,7	7,6	5,7	9,5	13,2	8,3	13,0	21,2
Shear $V_{Rec}$	[kN]	6,1	8,1	8,1	6,5	13,3	13,3	16,6	21,4	21,4
Cracked concrete										
Tensile $N_{Rec}$	[kN]	2,9	4,3	5,7	4,6	7,7	9,4	5,9	9,3	15,1
Shear $V_{Rec}$	[kN]	4,3	8,1	8,1	4,6	13,3	13,3	11,9	18,5	21,4
		Hilti Tech. Data								
Anchor size		10			14					
Type	HUS3	HF			HF					
Nominal embedment depth	$h_{nom}$ [mm]	55	75	85	65	85				
Non-cracked concrete										
Tensile $N_{Rec}$	[kN]	5,7	9,5	13,2	8,3	13,0				
Shear $V_{Rec}$	[kN]	6,5	11,7	11,7	16,6	21,4				
Cracked concrete										
Tensile $N_{Rec}$	[kN]	4,6	7,7	9,4	5,9	9,3				
Shear $V_{Rec}$	[kN]	4,6	11,7	11,7	11,9	18,5				

a) With overall partial safety factor for action  $\gamma = 1,4$ . The partial safety factors for action depend on the type of loading and shall be taken from national regulations.

## Materials

### Mechanical properties

Anchor size		8	10	10	14
Type	HUS3	H, C	H, C	HF	H, HF
Nominal tensile strength $f_{uk}$	[N/mm <sup>2</sup> ]	810	805	705	730
Yield strength $f_{yk}$	[N/mm <sup>2</sup> ]	695	690	605	630
Stressed cross-section $A_s$	[mm <sup>2</sup> ]	48,4	77,0	77,0	131,7
Moment of resistance $W$	[mm <sup>3</sup> ]	47	95	95	213
Char, bending resistance $M_{Rk,s}^0$	[Nm]	46	92	81	187

**Material quality**

Type	Material	Coating
HUS3-H / HUS3-C	Carbon-steel	Galvanized ( $\geq 5 \mu\text{m}$ )
HUS3-HF	Carbon-steel	Multilayer coating ( $\geq 14 \mu\text{m}$ )

## Anchor dimensions

### Dimensions

Anchor size			8	10	14
Type			H, C	H, C, HF	H, HF
Threaded outer diameter	$d_t$	[mm]	10,30	12,40	16,85
Core diameter	$d_k$	[mm]	7,85	9,90	12,95
Shaft diameter	$d_s$	[mm]	8,45	10,55	13,80
Stressed section	$A_s$	[mm <sup>2</sup> ]	48,4	77,0	131,7

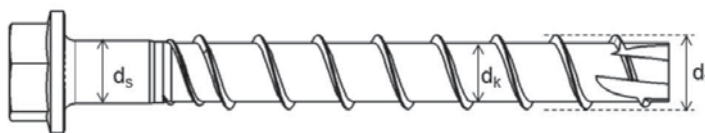

**HUS3** : Hilti Universal Screw 3<sup>rd</sup> generation

**H** : Hexagonal head

**10** : screw diameter

**45/25/15** : maximum thickness fixture  $t_{fix1}/t_{fix2}/t_{fix3}$  related to the embedment depth  $h_{nom1}/h_{nom2}/h_{nom3}$  (see Annex B3)

### Screw length and thickness of fixture for HUS3-H (hex head, galvanized)

Anchor size	HUS3-H	8			10			14		
		$h_{nom1}$ 50	$h_{nom2}$ 60	$h_{nom3}$ 70	$h_{nom1}$ 55	$h_{nom2}$ 75	$h_{nom3}$ 85	$h_{nom1}$ 65	$h_{nom2}$ 85	$h_{nom3}$ 115
Nominal anchorage depth [mm]	Length of anchor [mm]	Thickness of fixture [mm]								
		$t_{fix1}$	$t_{fix2}$	$t_{fix3}$	$t_{fix1}$	$t_{fix2}$	$t_{fix3}$	$t_{fix1}$	$t_{fix2}$	$t_{fix3}$
	55	5	-	-	-	-	-	-	-	-
	60	-	-	-	5	-	-	-	-	-
	65	15	5	-	-	-	-	-	-	-
	70	-	-	-	15	-	-	-	-	-
	75	25	15	5	-	-	10	-	-	-
	80	-	-	-	25	5	-	-	-	-
	85	35	25	15	-	-	-	-	-	-
	90	-	-	-	35	15	5	-	-	-
	100	50	40	30	45	25	15	35	15	-
	110	-	-	-	55	35	25	-	-	-
	120	70	60	50	-	-	-	-	-	-
	130	-	-	-	75	55	45	65	45	15
	150	100	90	80	95	75	65	85	65	35

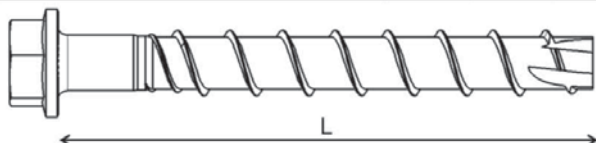

### Screw length and thickness of fixture for HUS3-HF (hex head, multilayer coating)

Anchor size	HUS3-HF	10			14	
Nominal anchorage depth [mm]	Length of anchor [mm]	$h_{nom1}$	$h_{nom2}$	$h_{nom3}$	$h_{nom1}$	$h_{nom2}$
		Thickness of fixture [mm]				
		$t_{fix1}$	$t_{fix2}$	$t_{fix3}$	$t_{fix1}$	$t_{fix2}$
60		5	-	-	-	-
75		-	-	-	10	-
80		25	5	-	-	-
100		45	25	15	35	15
110		55	35	25	-	-

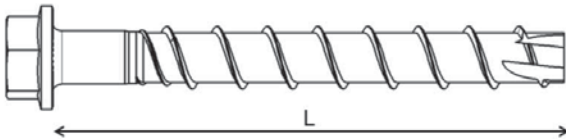

### Screw length and thickness of fixture for HUS3-C (countersunk head, galvanized)

Anchor size	HUS3-C	8			10		
Nominal anchorage depth [mm]	Length of anchor [mm]	$h_{nom1}$	$h_{nom2}$	$h_{nom3}$	$h_{nom1}$	$h_{nom2}$	$h_{nom3}$
		Thickness of fixture [mm]					
		$t_{fix1}$	$t_{fix2}$	$t_{fix3}$	$t_{fix1}$	$t_{fix2}$	$t_{fix3}$
65		15	5	-	-	-	-
70		-	-	-	15	-	-
75		25	15	-	-	-	-
85		35	25	15	-	-	-
90		-	-	-	35	15	-
100		-	-	-	45	25	15

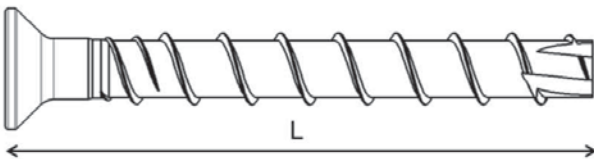



## Setting

### Installation equipment

Anchor size		8	10	14
Type	HUS3	H, C	H, C, HF	H, HF
Rotary hammer		TE 2 – TE 30	TE 2 – TE 30	TE 2 – TE 30
Drill bit for concrete, solid clay brick and solid sand-lime brick		CX 8	CX 10	CX 14
Drill bit for aerated concrete		CX 6	CX 8	-
Socket wrench insert		S-NSD 13 1/2	S-NSD 15 1/2	S-NSD 21 1/2
Torx		S-SY TX45	S-SY TX50	-
Tube for temporary application (only for H type)		HRG 8	HRG 10	HRG 14
Setting tool for concrete C12/15 to C50/60		SIW 22T-A		
Setting tool for solid brick and aerated concrete		SFH 22A		
Setting tool for hollow core slab		SIW 22 A		

### Setting details for concrete

Anchor size		8			10			14		
Type	HUS3	H, C			H, C, HF			H, HF		H
Nominal anchorage depth	$h_{nom}$ [mm]	50	60	70	55	75	85	65	85	115
Nominal diameter of drill bit	$d_o$ [mm]	8			10			14		
Cutting diameter of drill bit	$d_{cut} \leq$ [mm]	8,45			10,45			14,50		
Depth of drill hole	$h_1 \geq$ [mm]	60	70	80	65	85	95	75	95	125
Diameter of clearance hole in the fixture	$d_f \leq$ [mm]	12			14			18		
Diameter of countersunk head	$d_h$ [mm]	18			21			-		
Width across (H, HF types)	SW [mm]	13			15			21		
Torx (C type)	TX [-]	45			50			-		
Impact screw driver		Hilti SIW 22 T-A								

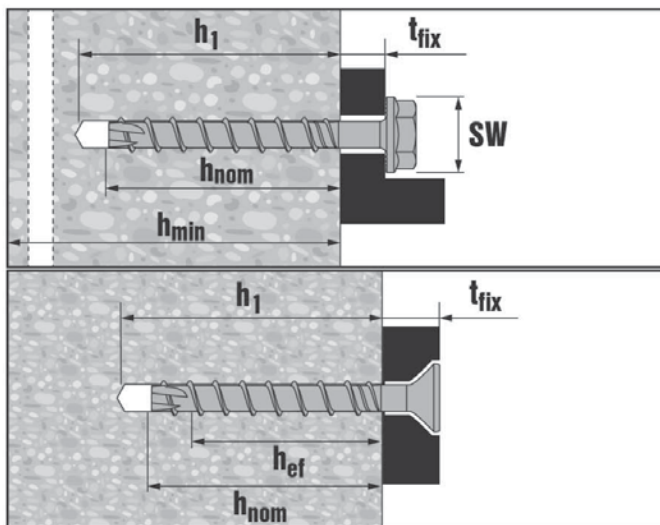

### Setting instruction

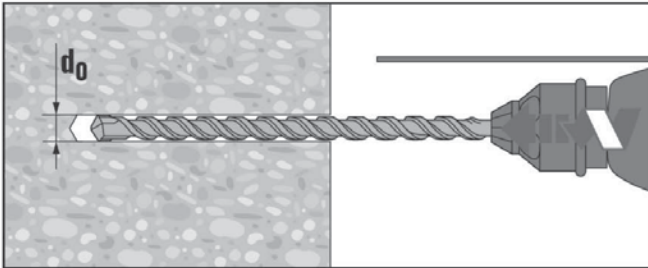

Make a cylindrical hole

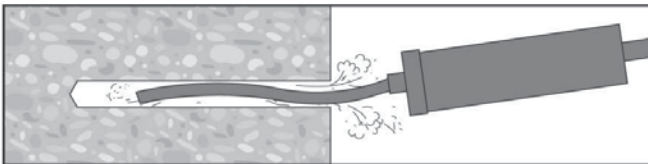

Clean the borehole

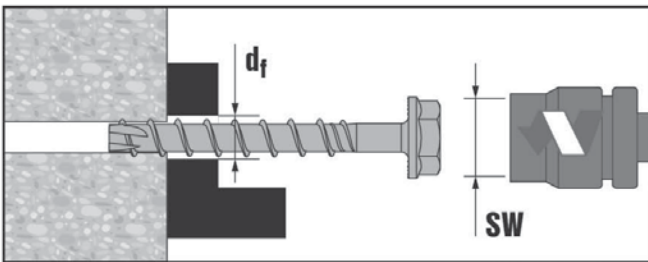

Install the screw anchor by impact screw driver Hilti SIW 22T-A

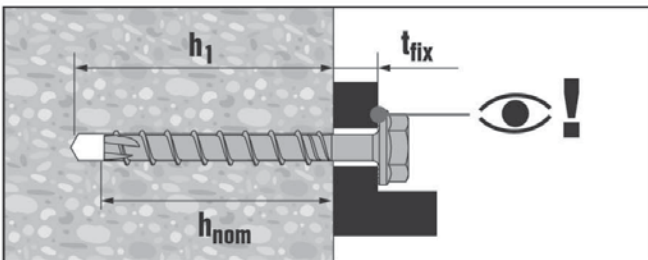

Ensure that the fixture is caught

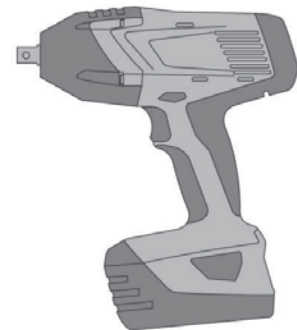

For detailed information on installation see instruction for use given with the package of the product.

### Setting instruction in case of adjustment process

(recommended for HUS3-H,C size 8 and 10 for standard embedment depth  $h_{nom2}$  only)

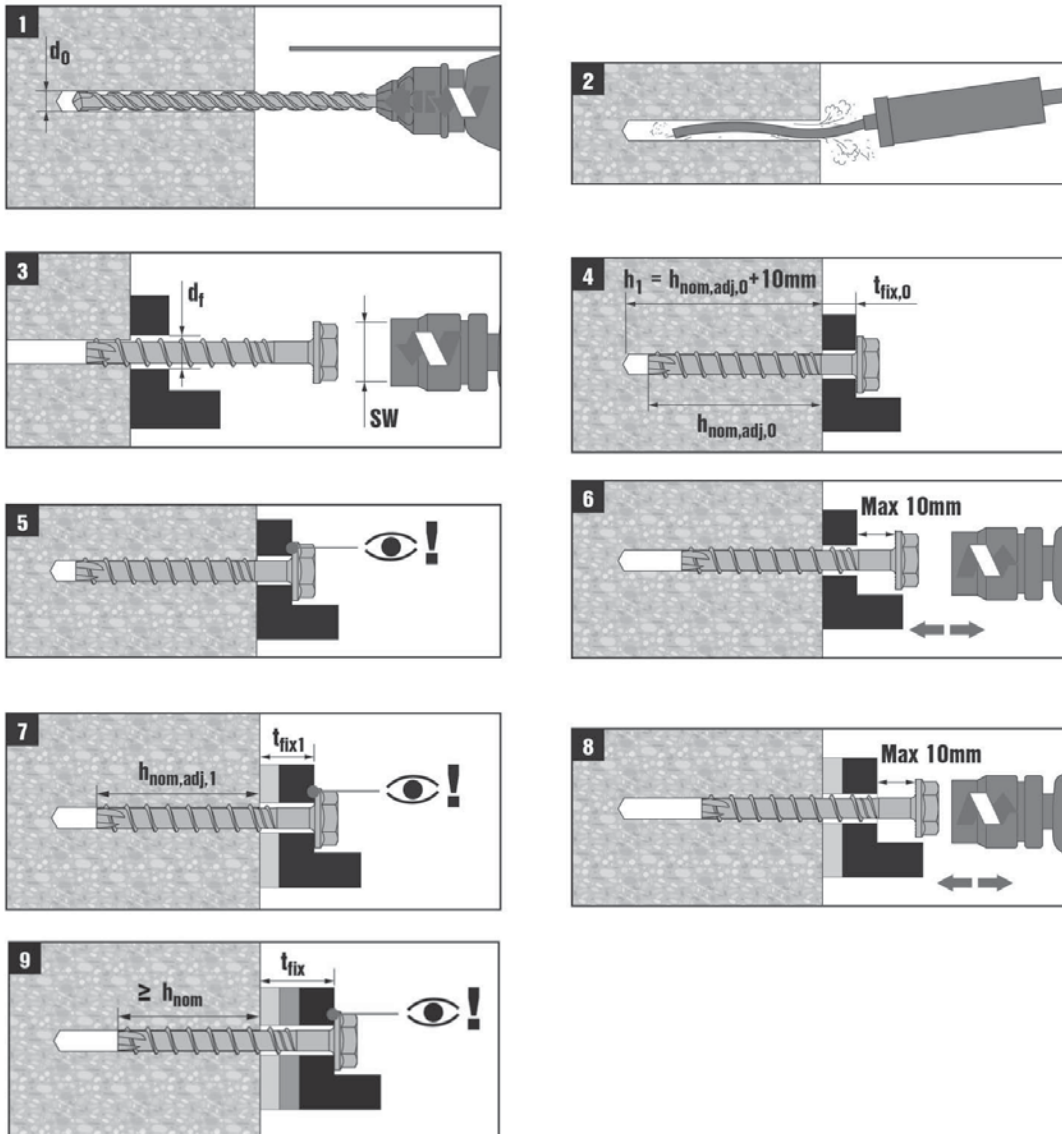

For setting HUS3-H,C 8 ( $h_{nom2}=60\text{mm}$ ) and HUS3-H,C 10 ( $h_{nom2}=75\text{mm}$ ) it is allowed to adjust (loosening max. 10mm and re-tightening) the screw. The adjustment can be done maximum two times,  $n_a=2$ . The final embedment depth after adjustment process must be larger or equal than  $h_{nom2}$ . The total allowed thickness of shims added during the adjustment process  $t_{adj}=10\text{mm}$ .

### Design parameters

Anchor size		8			10			14		
Type	HUS3	H, C			H, C, HF			H, HF		H
Nominal anchorage depth	$h_{nom}$ [mm]	50	60	70	55	75	85	65	85	115
Effective anchorage depth	$h_{ef}$ [mm]	40	46,4	54,9	41,6	58,6	67,1	49,3	66,3	91,8
Minimum base material thickness	$h_{min}$ [mm]	100	100	120	100	130	140	120	160	200
Minimum spacing	$s_{min}$ [mm]	40	50	50	50	50	60	60	75	75
Minimum edge distance	$c_{min}$ [mm]	50	50	50	50	50	60	60	75	75
Critical spacing for splitting failure	$s_{cr,sp}$ [mm]	120	140	170	130	180	220	170	200	280
Critical edge distance for splitting failure	$c_{cr,sp}$ [mm]	60	70	85	65	90	110	85	100	140
Critical spacing for concrete cone failure	$s_{cr,N}$ [mm]	120	140	170	130	180	202	150	200	280
Critical edge distance for concrete cone failure	$c_{cr,N}$ [mm]	60	70	85	65	90	101	75	100	140

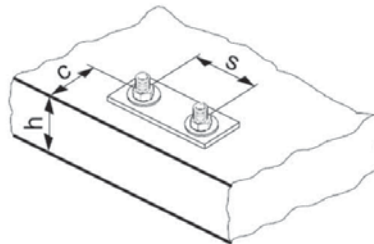

For spacing (edge distance) smaller than critical spacing (critical edge distance) the design loads have to be reduced.

### Simplified design method

Simplified version of the design method according ETAG 001, Annex C. Design resistance according ETA-13/1038, issue 2014-03-26 (HUS3-H and C types only).

- Influence of concrete strength
- Influence of edge distance
- Influence of spacing
- Valid for a group of two anchors. (The method may also be applied for anchor groups with more than two anchors or more than one edge. The influencing factors must then be considered for each edge distance and spacing. The calculated design loads are then conservative: They will be lower than the exact values according ETAG 001, Annex C. To avoid this, it is recommended to use the anchor design software PROFIS anchor).

The design method is based on the following simplification:

- No different loads are acting on individual anchors (no eccentricity)

The values are valid for one anchor.

For more complex fastening applications please use the anchor design software PROFIS Anchor.

## Tension loading

The design tensile resistance is the lower value of

- Steel resistance:  $N_{Rd,s}$
- Concrete pull-out resistance:  $N_{Rd,p} = N_{Rd,p}^0 \cdot f_B$
- Concrete cone resistance:  $N_{Rd,c} = N_{Rd,c}^0 \cdot f_B \cdot f_{1,N} \cdot f_{2,N} \cdot f_{3,N} \cdot f_{re,N}$
- Concrete splitting resistance (only non-cracked concrete):  
 $N_{Rd,sp} = N_{Rd,c}^0 \cdot f_B \cdot f_{1,sp} \cdot f_{2,sp} \cdot f_{3,sp} \cdot f_{h,sp} \cdot f_{re,N}$

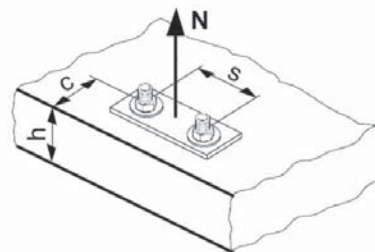

## Basic design tensile resistance

### Design steel resistance $N_{Rd,s}$

		Data according ETA-13/1038, 2014-09-19.		
Anchor size		8	10	14
Type	HUS3	H, C	H, C	H
$N_{Rd,s}$	[kN]	28,0	44,4	69,0
		Hilti Tech. Data		
Anchor size		10	14	
Type	HUS3	HF	HF	
$N_{Rd,s}$	[kN]	38,7	69,0	

**Design pull-out resistance  $N_{Rd,p} = N_{Rd,p}^0 \cdot f_B$** 

		Data according ETA-13/1038, 2014-09-19.								
Anchor size		8			10			14		
Type		H, C			H, C			H		
Nominal anchorage depth	$h_{nom}$ [mm]	50	60	70	55	75	85	65	85	115
Non-cracked concrete										
$N_{Rd,p}^0$	[kN]	6,0	8,0	10,7	8,0	13,3	No pull-out	No pull-out		
Cracked concrete										
$N_{Rd,p}^0$	[kN]	4,0	6,0	8,0	No pull-out			No pull-out		
		Hilti Tech. Data								
Anchor size		10			14					
Type		HF			HF					
Nominal anchorage depth	$h_{nom}$ [mm]	55	75	85	65	85				
Non-cracked concrete										
$N_{Rd,p}^0$	[kN]	8,0	13,3	No pull-out	No pull out					
Cracked concrete										
$N_{Rd,p}^0$	[kN]	No pull-out			No pull-out					

Design concrete cone resistance  $N_{Rd,c} = N_{Rd,c}^0 \cdot f_B \cdot f_{1,N} \cdot f_{2,N} \cdot f_{3,N} \cdot f_{re,N}$

Design splitting resistance <sup>a)</sup>  $N_{Rd,sp} = N_{Rd,c}^0 \cdot f_B \cdot f_{1,sp} \cdot f_{2,sp} \cdot f_{3,sp} \cdot f_{h,sp} \cdot f_{re,N}$

		Data according ETA-13/1038, 2014-09-19.								
Anchor size		8			10			14		
Type	HUS3	H, C			H, C			H		
Nominal anchorage depth	$h_{nom}$ [mm]	50	60	70	55	75	85	65	85	115
Non-cracked concrete										
$N_{Rd,c}^0$	[kN]	8,5	10,6	13,7	9,0	15,1	18,5	11,7	18,2	29,6
Cracked concrete										
$N_{Rd,c}^0$	[kN]	6,1	7,6	9,8	6,4	10,8	13,2	8,3	13,0	21,1
		Hilti Tech. Data								
Anchor size		10			14					
Type	HUS3	HF			HF					
Nominal anchorage depth	$h_{nom}$ [mm]	55	75	85	65	85				
Non-cracked concrete										
$N_{Rd,p}^0$	[kN]	9,0	15,1	18,5	11,7	18,2				
Cracked concrete										
$N_{Rd,p}^0$	[kN]	6,4	10,8	13,2	8,3	13,0				

## Influencing factors

### Influence of concrete strength

Concrete strength designation (ENV 206)	C 20/25	C 25/30	C 30/37	C 35/45	C 40/50	C 45/55	C 50/60
Pull-out, concrete cone and splitting resistance							
$f_B = (f_{ck,cube}/25N/mm^2)^{1/2}$ <sup>a)</sup>	1	1,1	1,22	1,34	1,41	1,48	1,55

a)  $f_{ck,cube}$  = concrete compressive strength, measured on cubes with 150 mm side length.

### Influence of edge distance <sup>a)</sup>

$c/c_{cr,N}$	0,1	0,2	0,3	0,4	0,5	0,6	0,7	0,8	0,9	1
$c/c_{cr,sp}$										
$f_{1,N} = 0,7 + 0,3 \cdot c/c_{cr,N} \leq 1$	0,73	0,76	0,79	0,82	0,85	0,88	0,91	0,94	0,97	1
$f_{1,sp} = 0,7 + 0,3 \cdot c/c_{cr,sp} \leq 1$										
$f_{2,N} = 0,5 \cdot (1 + c/c_{cr,N}) \leq 1$	0,55	0,60	0,65	0,70	0,75	0,80	0,85	0,90	0,95	1
$f_{2,sp} = 0,5 \cdot (1 + c/c_{cr,sp}) \leq 1$										

a) The edge distance shall not be smaller than the minimum edge distance  $c_{min}$  given in the table with the setting details. These influencing factors must be considered for every edge distance.

### Influence of anchor spacing <sup>a)</sup>

$s/s_{cr,N}$	0,1	0,2	0,3	0,4	0,5	0,6	0,7	0,8	0,9	1
$s/s_{cr,sp}$										
$f_{3,N} = 0,5 \cdot (1 + s/s_{cr,N}) \leq 1$	0,55	0,60	0,65	0,70	0,75	0,80	0,85	0,90	0,95	1
$f_{3,sp} = 0,5 \cdot (1 + s/s_{cr,sp}) \leq 1$										

a) The anchor spacing shall not be smaller than the minimum anchor spacing  $s_{min}$  given in the table with the setting details. This influencing factor must be considered for every anchor spacing.

### Influence of base material thickness

$h/h_{min}$	1,0	1,1	1,2	1,3	1,4	1,5	1,6	1,7	1,8	$\geq 1,84$
$f_{h,sp} = [h/(h_{min})]^{2/3}$	1	1,07	1,13	1,19	1,25	1,31	1,37	1,42	1,48	1,5

### Influence of reinforcement <sup>a)</sup>

Anchor size		8			10			14		
Type	HUS3	H, C, HF			H, C, HF			H, HF		
Nominal anchorage depth	$h_{nom}$ [mm]	50	60	70	55	75	85	65	85	115
$f_{re,N} = 0,5 + h_{ef}/200mm \leq 1$		0,70	0,73	0,77	0,71	0,79	0,84	0,75	0,83	0,96

c) This factor applies only for dense reinforcement. If in the area of anchorage there is reinforcement with a spacing  $\geq 150$  mm (any diameter) or with a diameter  $\leq 10$  mm and a spacing  $\geq 100$  mm, then a factor  $f_{re,N} = 1$  may be applied.

## Shear loading

The design shear resistance is the lower value of

- Steel resistance:  $V_{Rd,s}$
- Concrete pryout resistance:  $V_{Rd,cp} = k \cdot N_{Rd,c}$
- Concrete edge resistance:  $V_{Rd,c} = V_{Rd,c}^0 \cdot f_B \cdot f_B \cdot f_h \cdot f_4 \cdot f_{hef} \cdot f_c$

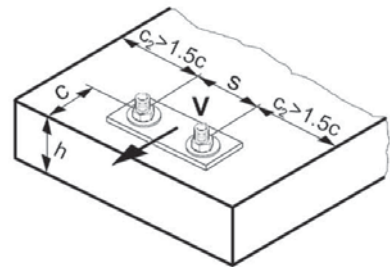



### Basic design shear resistance

#### Design steel resistance $V_{Rd,s}$

		Data according ETA-13/1038, issue 2014-09-19.		
Anchor size		8	10	14
Type	HUS3	H, C	H, C	H,
$V_{Rd,s}$	[kN]	11,3	18,7	30,0
		Hilti Tech. Data		
Anchor size		10	14	
Type	HUS3	HF	HF	
$V_{Rd,s}$	[kN]	16,3	30,0	

#### Design concrete pry-out resistance $V_{Rd,cp} = k \cdot N_{Rd,c}$ <sup>a)</sup>

		Data according ETA-13/1038, issue 2014-09-19.								
Anchor size		8			10			14		
Type	HUS3	H, C			H, C, HF			H, HF	H	
Nominal anchorage depth	$h_{nom}$ [mm]	50	60	70	55	75	85	65	85	115
k		1,0	2,0	2,0	1,0	2,0	2,0	2,0	2,0	2,0
		Hilti Tech. Data								
Anchor size		10			14					
Type	HUS3	HF			HF					
Nominal anchorage depth	$h_{nom}$ [mm]	55	75	85	65	85				
k	[kN]	1,0	2,0	2,0	2,0	2,0				

a)  $N_{Rd,c}$ : Design concrete cone resistance

Design concrete edge resistance  $a) V_{Rd,c} = V_{Rd,c}^0 \cdot f_B \cdot f_{\beta} \cdot f_h \cdot f_4 \cdot f_{hef} \cdot f_c$

		Data according ETA-13/1038, issue 2014-09-19.								
Anchor size		8			10			14		
Type	HUS3	H, C			H, C			H		
Nominal anchorage depth	$h_{nom}$ [mm]	50	60	70	55	75	85	65	85	115
Non-cracked concrete										
$V_{Rd,c}^0$	[kN]	6,0	6,0	6,0	8,6	8,6	8,6	15,0	15,1	15,2
Cracked concrete										
$V_{Rd,c}^0$	[kN]	4,2	4,2	4,2	6,1	6,1	6,1	10,6	10,7	10,7
Hilti Tech. Data										
Anchor size		10			14					
Type	HUS3	HF			HF					
Nominal anchorage depth	$h_{nom}$ [mm]	55	75	85	65	85				
Non-cracked concrete										
$V_{Rd,c}^0$	[kN]	8,6	8,6	8,6	15,0	15,1				
Cracked concrete										
$V_{Rd,c}^0$	[kN]	6,1	6,1	6,1	10,6	10,7				

c) For anchor groups only the anchors close to the edge must be considered.

### Influencing factors

#### Influence of concrete strength

Concrete strength designation (ENV 206)	C 20/25	C 25/30	C 30/37	C 35/45	C 40/50	C 45/55	C 50/60
$f_B = (f_{ck,cube}/25N/mm^2)^{1/2}$ a)	1	1,1	1,22	1,34	1,41	1,48	1,55

a)  $f_{ck,cube}$  = concrete compressive strength, measured on cubes with 150 mm side length.

#### Influence of angle between load applied and the direction perpendicular to the free edge

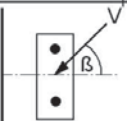
Angle $\beta$	0°	10°	20°	30°	40°	50°	60°	70°	80°	≥ 90°
$f_{\beta} = \sqrt{\frac{1}{(\cos \alpha_v)^2 + \left(\frac{\sin \alpha_v}{2,5}\right)^2}}$ 	1	1,01	1,05	1,13	1,24	1,40	1,64	1,97	2,32	2,50

#### Influence of base material thickness

$h/c$	0,15	0,3	0,45	0,6	0,75	0,9	1,05	1,2	1,35	≥ 1,5
$f_h = \{h/(1,5 \cdot c)\}^{1/2} \leq 1$	0,32	0,45	0,55	0,63	0,71	0,77	0,84	0,89	0,95	1,00

Influence of anchor spacing and edge distance <sup>a)</sup> for concrete edge resistance:  $f_4$   
 $f_4 = (c/h_{ef})^{1,5} \cdot (1 + s / [3 \cdot c]) \cdot 0,5$

c/h <sub>ef</sub>	Single anchor	Group of two anchors s/h <sub>ef</sub>														
		0,75	1,50	2,25	3,00	3,75	4,50	5,25	6,00	6,75	7,50	8,25	9,00	9,75	10,50	11,25
0,50	0,35	0,27	0,35	0,35	0,35	0,35	0,35	0,35	0,35	0,35	0,35	0,35	0,35	0,35	0,35	0,35
0,75	0,65	0,43	0,54	0,65	0,65	0,65	0,65	0,65	0,65	0,65	0,65	0,65	0,65	0,65	0,65	0,65
1,00	1,00	0,63	0,75	0,88	1,00	1,00	1,00	1,00	1,00	1,00	1,00	1,00	1,00	1,00	1,00	1,00
1,25	1,40	0,84	0,98	1,12	1,26	1,40	1,40	1,40	1,40	1,40	1,40	1,40	1,40	1,40	1,40	1,40
1,50	1,84	1,07	1,22	1,38	1,53	1,68	1,84	1,84	1,84	1,84	1,84	1,84	1,84	1,84	1,84	1,84
1,75	2,32	1,32	1,49	1,65	1,82	1,98	2,15	2,32	2,32	2,32	2,32	2,32	2,32	2,32	2,32	2,32
2,00	2,83	1,59	1,77	1,94	2,12	2,30	2,47	2,65	2,83	2,83	2,83	2,83	2,83	2,83	2,83	2,83
2,25	3,38	1,88	2,06	2,25	2,44	2,63	2,81	3,00	3,19	3,38	3,38	3,38	3,38	3,38	3,38	3,38
2,50	3,95	2,17	2,37	2,57	2,77	2,96	3,16	3,36	3,56	3,76	3,95	3,95	3,95	3,95	3,95	3,95
2,75	4,56	2,49	2,69	2,90	3,11	3,32	3,52	3,73	3,94	4,15	4,35	4,56	4,56	4,56	4,56	4,56
3,00	5,20	2,81	3,03	3,25	3,46	3,68	3,90	4,11	4,33	4,55	4,76	4,98	5,20	5,20	5,20	5,20
3,25	5,86	3,15	3,38	3,61	3,83	4,06	4,28	4,51	4,73	4,96	5,18	5,41	5,63	5,86	5,86	5,86
3,50	6,55	3,51	3,74	3,98	4,21	4,44	4,68	4,91	5,14	5,38	5,61	5,85	6,08	6,31	6,55	6,55
3,75	7,26	3,87	4,12	4,36	4,60	4,84	5,08	5,33	5,57	5,81	6,05	6,29	6,54	6,78	7,02	7,26
4,00	8,00	4,25	4,50	4,75	5,00	5,25	5,50	5,75	6,00	6,25	6,50	6,75	7,00	7,25	7,50	7,75
4,25	8,76	4,64	4,90	5,15	5,41	5,67	5,93	6,18	6,44	6,70	6,96	7,22	7,47	7,73	7,99	8,25
4,50	9,55	5,04	5,30	5,57	5,83	6,10	6,36	6,63	6,89	7,16	7,42	7,69	7,95	8,22	8,49	8,75
4,75	10,35	5,45	5,72	5,99	6,27	6,54	6,81	7,08	7,36	7,63	7,90	8,17	8,45	8,72	8,99	9,26
5,00	11,18	5,87	6,15	6,43	6,71	6,99	7,27	7,55	7,83	8,11	8,39	8,66	8,94	9,22	9,50	9,78
5,25	12,03	6,30	6,59	6,87	7,16	7,45	7,73	8,02	8,31	8,59	8,88	9,17	9,45	9,74	10,02	10,31
5,50	12,90	6,74	7,04	7,33	7,62	7,92	8,21	8,50	8,79	9,09	9,38	9,67	9,97	10,26	10,55	10,85

a) The anchor spacing and the edge distance shall not be smaller than the minimum anchor spacing  $s_{min}$  and the minimum edge distance  $c_{min}$ .

**Influence of embedment depth**

Anchor size		8			10			14		
Type	HUS3	H, C			H, C, HF			H, HF		H
Nominal anchorage depth	$h_{nom}$ [mm]	50	60	70	55	75	85	65	85	115
$f_{hef} = 0,05 \cdot (h_{ef} / d)^{1,68}$		0,75	0,96	1,27	0,55	0,98	1,22	0,41	0,68	1,18

**Influence of edge distance <sup>a)</sup>**

c/d	4	6	8	10	15	20	30	40
$f_c = (d / c)^{0,19}$	0,77	0,71	0,67	0,65	0,60	0,57	0,52	0,50

a) The edge distance shall not be smaller than the minimum edge distance  $c_{min}$ .

## Basic loading data for concrete C20/25 – C50/60

All data in this section applies to:

- Correct setting (see setting instruction)
- No edge distance and spacing influence
- Minimum base material thickness
- HUS3-H only.

The following technical data are based on: ETA-13/1038 issue 2014-09-19.

### Recommended loads under fire exposure

Anchor size		HUS3 H	8			10			14		
			$h_{nom1}$	$h_{nom2}$	$h_{nom3}$	$h_{nom1}$	$h_{nom2}$	$h_{nom3}$	$h_{nom1}$	$h_{nom2}$	$h_{nom3}$
Nominal embedment depth		$h_{nom}$ [mm]	50	60	70	55	75	85	65	85	115
Steel failure for tension and shear load ( $F_{Rec,s,fi} = N_{Rec,s,fi} = V_{Rec,s,fi}$ )											
Recommended tensile and shear load	R30	$F_{Rec,s,fi}$ [kN]	2,3	2,5	2,7	4,4	4,4	7,4	7,6		
	R60	$F_{Rec,s,fi}$ [kN]	1,7	1,9	2,0	3,3	3,4	5,6	5,8		
	R90	$F_{Rec,s,fi}$ [kN]	1,1	1,1	1,4	2,2	2,3	3,8	3,9		
	R120	$F_{Rec,s,fi}$ [kN]	0,9	0,9	1,1	1,7	1,8	2,9	3,1		
	R30	$M_{Rec,s,fi}^0$ [Nm]	10,4	11,4	12,3	25,1	25,4	56,4	57,0		
	R60	$M_{Rec,s,fi}^0$ [Nm]	7,9	8,4	9,3	19,0	19,4	42,6	43,4		
	R90	$M_{Rec,s,fi}^0$ [Nm]	5,3	5,3	6,3	12,9	13,3	28,7	29,8		
	R120	$M_{Rec,s,fi}^0$ [Nm]	4,1	3,8	4,9	9,8	10,3	21,9	22,9		
Pull-out failure											
Recommended resistance	R30 R60 R90	$N_{Rec,p,fi}$ [kN]	1,1	1,6	2,1	1,7	2,9	3,5	2,2	3,4	5,6
	R120	$N_{Rec,p,fi}$ [kN]	0,9	1,3	1,7	1,4	2,3	2,8	1,8	2,7	4,5
Concrete cone failure											
Characteristic resistance	R30 R60 R90	$N_{Rec,c,fi}^0$ [kN]	1,3	1,9	2,9	1,4	3,4	4,7	2,1	4,6	10,3
	R120	$N_{Rec,c,fi}^0$ [kN]	1,0	1,5	2,3	1,1	2,7	3,8	1,7	3,6	8,2
Edge distance											
R30 to R120		$c_{cr,N}$ [mm]	2 $h_{ef}$								
Anchor spacing											
R30 to R120		$s_{cr,N}$ [mm]	4 $h_{ef}$								
Concrete pry-out failure											
R30 to R120		k [-]	1,0	2,0	1,0	2,0					

a) The recommended loads under fire exposure include a safety factor for resistance under fire exposure  $\gamma_{M,fi} = 1,0$  and the partial safety factor for action  $\gamma_{F,fi} = 1,0$ . The partial safety factors for action shall be taken from national regulations.

## Seismic design

### Basic loading data for concrete C20/25 – C50/60

All data in this section applies to:

- Seismic design according to TR045
- HUS3-H and HUS3-C only

The following technical data are based on: ETA-13/1038 issue 2014-09-19.

### Anchorage depth range

Anchor size		8	10	14
Type	HUS3	H, C	H, C	H
Nominal anchorage depth range	$h_{nom}$ [mm]	70	85	115

### Tension resistance in case of seismic performance category C1

Anchor size		8	10	14
Type	HUS3	H, C	H, C	H
<b>Characteristic tension resistance to steel failure</b>				
	$N_{Rk,s,seis}$ [kN]	39,2	62,2	96,6
Partial safety factor	$\gamma_{Ms,seis}$ [-]	1,4		
<b>Characteristic pull-out resistance in cracked concrete C20/25 to C50/60</b>				
	$N_{Rk,p,seis}$ [kN]	12	19,8	31,7
Partial safety factor	$\gamma_{Mp,seis}$ [-]	1,5		
<b>Concrete cone resistance and splitting resistance</b>				
Partial safety factor	$\gamma_{Mc,seis} = \gamma_{Msp,seis}$ [-]	1,5		

### Displacement under tension load in case of seismic performance category C1 <sup>1)</sup>

Anchor size		8	10	14
Type	HUS3	H, C	H, C	H
Displacement	$\delta_{N,seis}$ [mm]	0,6	0,9	1,3

1) Maximum displacement during cycling (seismic event).

### Shear resistance in case of seismic performance category C1 <sup>1)</sup>

Anchor size		8	10	14
Type	HUS3	H, C	H, C	H
<b>Characteristic shear resistance to steel failure</b>				
	$V_{Rk,s,seis}$ [kN]	11,9	16,8	22,5
Partial safety factor	$\gamma_{Ms,seis}$ [-]	1,5		
<b>Concrete pryout resistance and concrete edge resistance</b>				
Partial safety factor	$\gamma_{Mc,seis}$ [-]	1,5		

1) Reduction factor  $\alpha_{gap} = 1,0$  when using the Hilti Dynamic Set

### Displacement under tension load in case of seismic performance category C1 <sup>1)</sup>

Anchor size		8	10	14
Type	HUS3	H, C	H, C	H
Displacement	$\delta_{V,seis}$ [mm]	5,3	4,3	5,5

1) Maximum displacement during cycling (seismic event)

## Basic loading data for temporary application in standard and fresh concrete < 28 days old, $f_{ck,cube} \geq 10 \text{ N/mm}^2$ :

All data in this section applies to the following conditions:

- Strength class,  $f_{ck,cube} \geq 10 \text{ N/mm}^2$
- Only temporary use
- Screw is reusable, before each usage it must be checked according Hilti instruction for use with the suited tube Hilti HRG
- Design resistance and recommended load are valid for single anchor only
- Design resistance as well as the recommended load are valid for all load direction and valid for both cracked and non-cracked concrete
- Minimum base material thickness
- No edge distance and spacing influence
- Valid for HUS3-H only.

a) All data given in this section for HUS3-H sizes 10 and 14 according DIBt approval Z-21.8-2018 issue 2014-04-01

### Design resistance

			Hilti Tech. Data			DIBt approval Z-21.8-2018					
Anchor size	HUS3-H		8			10			14		
Nominal embedment depth	$h_{nom}$	[mm]	50	60	70	55	75	85	65	85	115
Cracked and non-cracked concrete											
Tensile $N_{Rd}$ = Shear $V_{Rd}$											
	$f_{ck,cube} \geq 10 \text{ N/mm}^2$	[kN]	2,5	3,2	4,7	3,3	5,3	6,3	4,4	7,0	12,3
	$f_{ck,cube} \geq 15 \text{ N/mm}^2$	[kN]	3,1	4,0	5,7	4,0	6,4	7,8	5,4	8,5	15,0
	$f_{ck,cube} \geq 20 \text{ N/mm}^2$	[kN]	3,6	4,6	6,6	4,7	7,4	9,0	6,2	9,9	17,3

### Recommended load

			Hilti Tech. Data			DIBt approval Z-21.8-2018					
Anchor size	HUS3-H		8			10			14		
Nominal embedment depth	$h_{nom}$	[mm]	50	60	70	55	75	85	65	85	115
Tensile $N_{rec}$ = Shear $V_{rec}$											
	$f_{ck,cube} \geq 10 \text{ N/mm}^2$	[kN]	1,8	2,3	3,4	2,4	3,8	4,5	3,1	5,0	8,8
	$f_{ck,cube} \geq 15 \text{ N/mm}^2$	[kN]	2,2	2,9	4,1	2,9	4,6	5,5	3,8	6,1	10,7
	$f_{ck,cube} \geq 20 \text{ N/mm}^2$	[kN]	2,6	3,3	4,7	3,3	5,3	6,4	4,4	7,1	12,4

a) With overall partial safety factor for action  $\gamma = 1,4$ . The partial safety factors for action depend on the type of loading and shall be taken from national regulations.

**Setting details**

			Hilti			DIBt approval Z-21.8-2018					
Anchor size	HUS3-H		8			10			14		
Nominal anchorage depth	$h_{nom}$	[mm]	50	60	70	55	75	85	65	85	115
Minimum base material thickness	$h_{min}$	[mm]	100	115	145	115	150	175	130	175	255
Minimum spacing	$s_{min}$	[mm]	180	225	285	225	300	345	255	345	510
Minimum edge distance direction 1	$c_1$	[mm]	60	75	95	75	100	115	85	115	170
Minimum edge distance direction 2	$c_2$	[mm]	95	115	145	115	150	175	130	180	260

**Setting details**

			Hilti			DIBt approval Z-21.8-2018					
Anchor size	HUS3-H		8			10			14		
Nominal anchorage depth	$h_{nom}$	[mm]	50	60	70	55	75	85	65	85	115
Nominal diameter of drill bit	$d_o$	[mm]	8			10			14		
Cutting diameter of drill bit	$d_{cut} \leq$	[mm]	8,45			10,45			14,50		
Depth of drill bit	$h_1 \leq$	[mm]	60	70	80	65	85	95	75	95	125
Diameter of clearance hole in the fixture	$d_f \leq$	[mm]	12			14			18		
Width across	SW	[mm]	13			15			21		
Impact screw driver			Hilti SIW 22 T-A								
Suited tube			Hilti HRG 8			Hilti HRG 10			Hilti HRG 14		

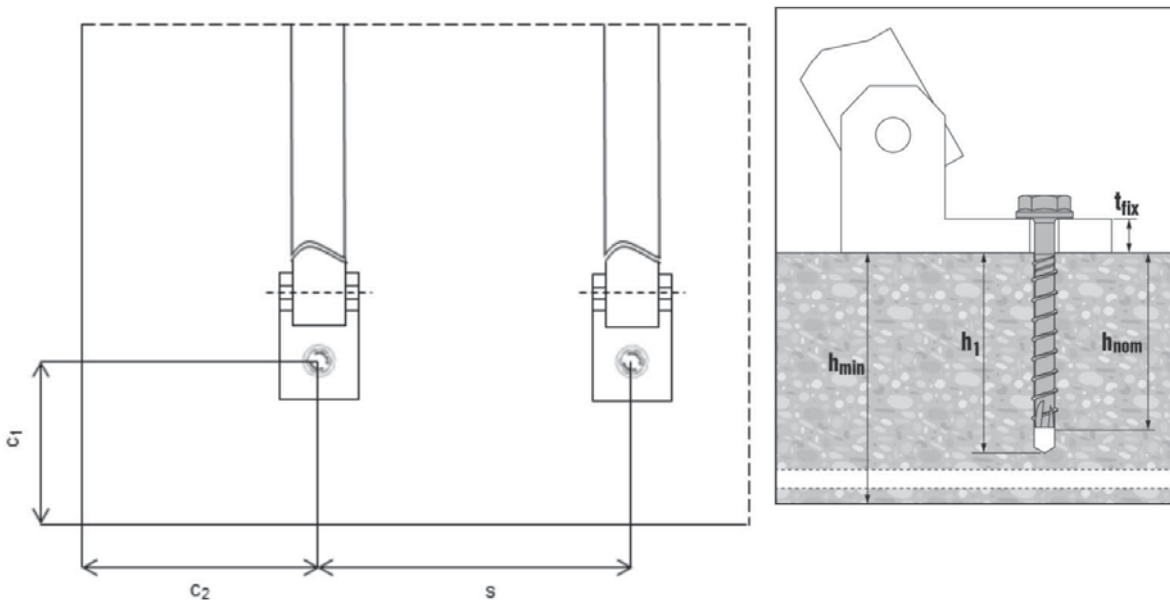

### Tube specification

Anchor size / tube		8 / HRG 8	10 / HRG 10	14 / HRG 14
Inner tube diameter	$\varnothing_i$ [mm]	9,7	11,7	16,0
Outer tube diameter	$\varnothing_e$ [mm]	15,0	17,0	22,0
Tube length	Lt [mm]	23,0	28,0	40,3

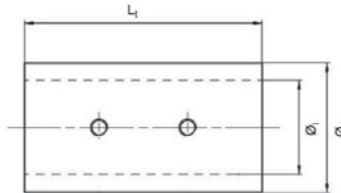

### Instruction for use – re-use of screw

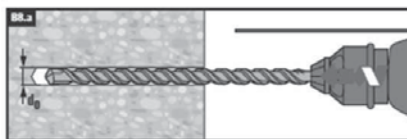
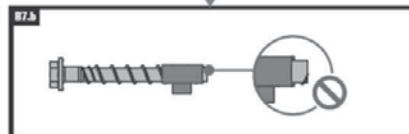
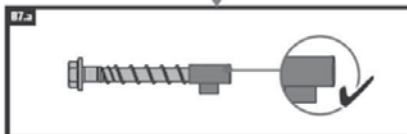
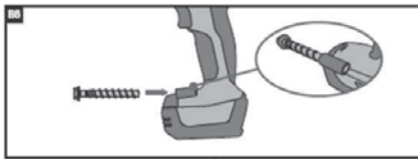
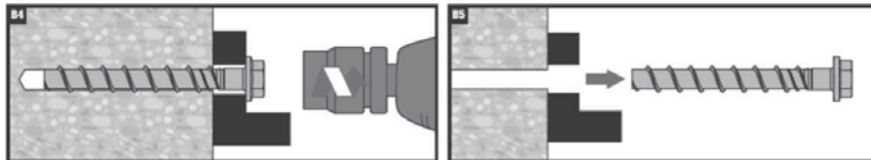
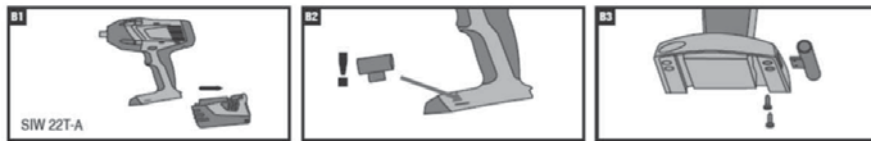



## Basic loading data for single anchor in solid masonry units:

All data in this section applies to the following conditions:

**Solid bricks:** a reduction of the cross section area by a vertical perforation perpendicular to the bed joint area must not be greater than 15%

### Drilling:

- Holes in Mz and KS drilled with TE rotary hammers drilled with hammering mode
- Holes in PPW drilled with TE rotary hammers drilled without hammering mode

### Installation:

- The anchor is correct mounted, if there is neither a turn-through or spinning of the screw in the drill hole nor that an easy turning of the screw is possible after the installation procedure when the head of the screw has touched the fixture
- The recommended setting tool is Hilti SFH 22A

### Edge distance and spacing influences:

- Distance to free edge free edge to solid masonry (Mz and KS) units  $c_{\min, \text{free}} \geq 200 \text{ mm}$
- Distance to free edge free edge to solid masonry (autoclaved aerated gas concrete) units  $c_{\min, \text{free}} \geq 170 \text{ mm}$
- The minimum distance to horizontal and vertical mortar joint  $c_{\min, \text{h}}$  and  $c_{\min, \text{v}}$  is stated in drawing below
- Minimum anchor spacing in one brick/block is  $s_{\min} = 80 \text{ mm}$

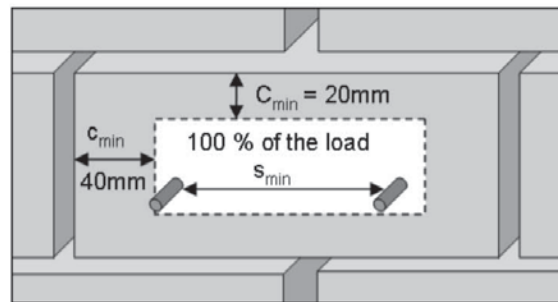

The minimum edge distance to vertical mortar joint for aerated gas concrete is 100mm,

### Recommended loads

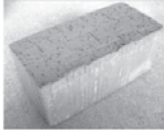
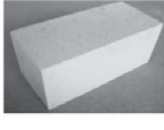
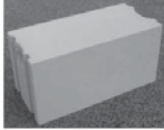
		Hilti	
		8	10
Base material	Anchor size		
	Type	HUS3	H, C
	h <sub>nom</sub>	[mm]	60
	Compressive strength class	[N/mm <sup>2</sup> ]	F <sub>rec</sub> <sup>a)</sup> [kN] Tensile and Shear
 <b>Solid clay brick</b> <b>Mz 2,0-2DF</b> DIN V 105-100 / EN 771-1 l [mm]: 240x115x113 h <sub>min</sub> [mm]: 115	≥ 12	1,1	1,4
	≥ 20	1,6	2,0
 <b>Solid sand-lime brick</b> <b>KS 2,0-2DF</b> DIN V 106-100 / EN 771-2 LxWxH [mm]: 240x115x113 h <sub>min</sub> [mm]: 115	≥ 12	1,3	1,4
	≥ 20	1,7	2,1
 <b>Aerated concrete</b> <b>PPW 6-0,4</b> DIN 4165 / EN 771-4 LxWxH [mm]: 499x240x249 h <sub>min</sub> [mm]: 240	≥ 6	0,7	0,9

a) Characteristic resistance for tension, shear or combined tension and shear loading.  
 The characteristic resistance is valid for single anchor or for a group of two or four anchors with spacing equal or larger than the minimum spacing  $s_{min}$  according to specification.

### Load values:

- The technical data for the HUS3 anchors are reference loads for MZ 12 2,0-2DF, KS 12 2,0-2DF and PPW 6-0,4.
- The load Values are valid for non-structural applications.
- Due to the natural variation of stone solid bricks, on site anchor testing is recommended to validate technical data.
- The HUS3 anchor was installed and tested in the center area of solid bricks as shown considering minimal edge and space distances.
- The HUS3 anchor was not tested in the mortar joint between solid bricks or in hollow bricks; however a load reduction is expected.
- For brick walls where anchor position in brick cannot be determined, 100% anchor testing is recommended.

**Limitations of loads:**

- All data is for redundant fastening for not structural applications
- Plaster, graveling, lining or leveling courses are regarded as non-bearing and may not be taken into account for the calculation of embedment depth,
- The decisive resistance to tension loads is the lower value of  $N_{rec}$  (brick breakout, pull out) and  $N_{max,pb}$  (pull out of one brick),

**Pull out of one brick:**

The allowable load of an anchor or a group of anchors in case of single brick pull out,  $N_{max,pb}$  [kN], is given in the following tables:

**Clay bricks:**

$N_{max,pb}$ [kN]		brick breadth $b_{brick}$ [mm]					
		80	120	200	240	300	360
brick length $l_{brick}$ [mm]	240	1,1	1,6	2,7	3,3	4,1	4,9
	300	1,4	2,1	3,4	4,1	5,1	6,2
	500	2,3	3,4	5,7	6,9	8,6	10,3

**All other brick types:**

$N_{max,pb}$ [kN]		brick breadth $b_{brick}$ [mm]					
		80	120	200	240	300	360
brick length $l_{brick}$ [mm]	240	0,8	1,2	2,1	2,5	3,1	3,7
	300	1,0	1,5	2,6	3,1	3,9	4,6
	500	1,7	2,6	4,3	5,1	6,4	7,7

$N_{max,pb}$  = resistance for pull out of one brick  
 $l_{brick}$  = length of the brick  
 $b_{brick}$  = breadth of the brick

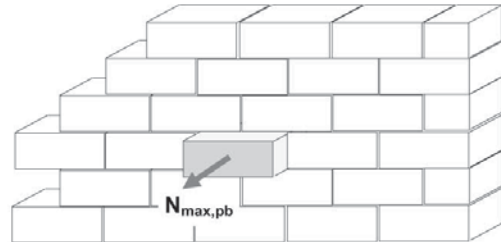
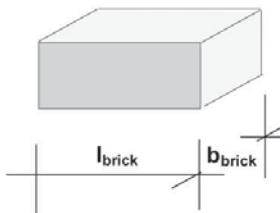

### Basic loading data for single anchor in Hollow core slab:

#### Basic loading data

All data in this section applies to

- Correct setting (See setting instruction)
- No edge distance and spacing influence
- Ratio core width / web thickness  $w/e \leq 4,2$
- Concrete C 30/37 to C 50/60

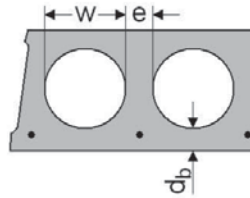

#### Characteristic resistance

Anchor size			8	10
Type	HUS3		C, H	C, H, HF
Bottom flange thickness	$d_b \geq$	[mm]	30	30
All load directions	$F_{Rk}$	[kN]	2,0	2,0

#### Design resistance

Anchor size			8	10
Type	HUS3		C, H	C, H, HF
Bottom flange thickness	$d_b \geq$	[mm]	30	30
All load directions	$F_{Rd}$	[kN]	1,3	1,3

#### Recommended loads

Anchor size			8	10
Type	HUS3		C, H	C, H, HF
Bottom flange thickness	$d_b \geq$	[mm]	30	30
All load directions <sup>a)</sup>	$F_{rec}$	[kN]	0,95	0,95

a) With overall partial safety factor for action  $\gamma = 1,4$ . The partial safety factors for action depend on the type of loading and shall be taken from national regulations.

#### Requirements for redundant fastening

The definition of redundant fastening according to Member States is given in the ETAG 001 Part six, Annex 1, In Absence of a definition by a Member State the following default values may be taken

Minimum number of fixing points	Minimum number of anchors per fixing point	Maximum design load of action $N_{Sd}$ per fixing point <sup>a)</sup>
3	1	2 kN
4	1	3 kN

a) The value for maximum design load of actions per fastening point  $N_{Sd}$  is valid in general that means all fastening points are considered in the design of the redundant structural system. The value  $N_{Sd}$  may be increased if the failure of one (= most unfavourable) fixing point is taken into account in the design (serviceability and ultimate limit state) of the structural system e.g. suspended ceiling.

### Setting

Anchor size		8	10
Type	HUS3	C, H	C, H, HF
Rotary hammer		Hilti TE 6 / TE 7	
drill bit		TE-CX 4	
Impact screw driver		SIW 22 A, 1 <sup>st</sup> or 2 <sup>nd</sup> gear	

### Setting instruction

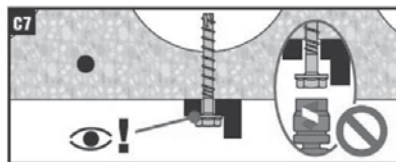
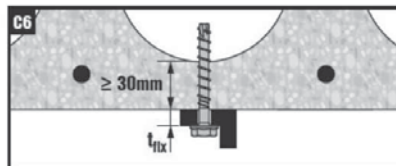
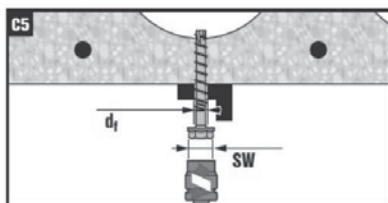
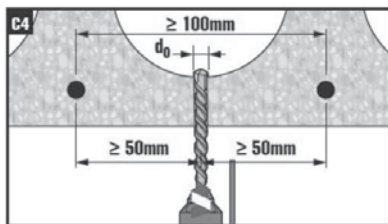
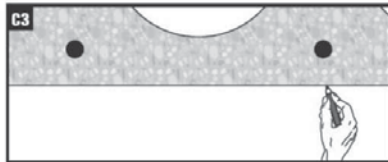
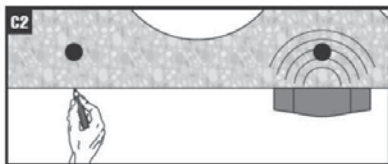
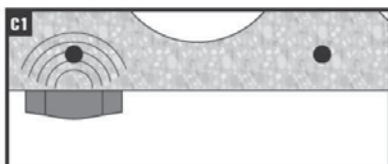
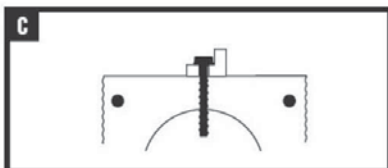

**Setting details**

Anchor size				8	10
Type	HUS3			C, H	C, H, HF
Nominal embedment depth	$h_{nom} \geq$	[mm]		40	45
Bottom flange thickness	$d_b \geq$	[mm]		30	30
Nominal diameter of drill bit	$d_o$	[mm]		8	10
Cutting diameter of drill bit	$d_{cut} \leq$	[mm]		8,45	10,45
Nominal depth of drill hole <sup>a)</sup>	$h_1 \geq$	[mm]		40	40
Diameter of clearance hole in the fixture	$d_f \leq$	[mm]		12	14
Nominal effective anchorage depth	$h_{ef}$	[mm]		30	30
Distance between anchor position and prestressing steel	$a_p \geq$	[mm]		50	50

a) Nominal depth of drill hole may be deeper than bottom flange thickness

Type	Size	Length	$d_b=30$ [mm]		$d_b=35$ [mm]		$d_b=40$ [mm]		$d_b=50$ [mm]	
			$t_{fix,min}$ [mm]	$t_{fix,max}$ [mm]	$t_{fix,min}$ [mm]	$t_{fix,max}$ [mm]	$t_{fix,min}$ [mm]	$t_{fix,max}$ [mm]	$t_{fix,min}$ [mm]	$t_{fix,max}$ [mm]
HUS3-H	8	55	5	15	5	10	5	5	5	5
		65	5	25	5	20	5	15	5	5
		75	5	35	5	30	5	25	5	15
		85	15	45	15	40	15	35	15	25
		100	30	60	30	55	30	50	30	40
		120	50	80	50	75	50	70	50	60
HUS3-C	8	65	15	25	15	20	15	15	15	5
		75	15	35	15	30	15	25	15	15
		85	15	45	15	40	15	35	15	25
HUS3-H	10	60	5	15	5	10	5	5	5	5
		70	15	25	15	20	15	15	15	5
		80	5	35	5	30	5	25	5	15
		90	5	45	5	40	5	35	5	25
		100	15	55	15	50	15	45	15	35
		110	25	65	25	60	25	55	25	45
		130	45	85	45	80	45	75	45	65
HUS3-HF	10	60	5	15	5	10	5	5	5	5
		80	5	35	5	30	5	25	5	15
		100	15	55	15	50	15	45	15	35
		110	25	65	25	60	25	55	25	45
HUS3-C	10	70	15	25	15	20	15	15	15	10
		90	15	45	15	40	15	35	15	25
		100	15	55	15	50	15	45	15	35

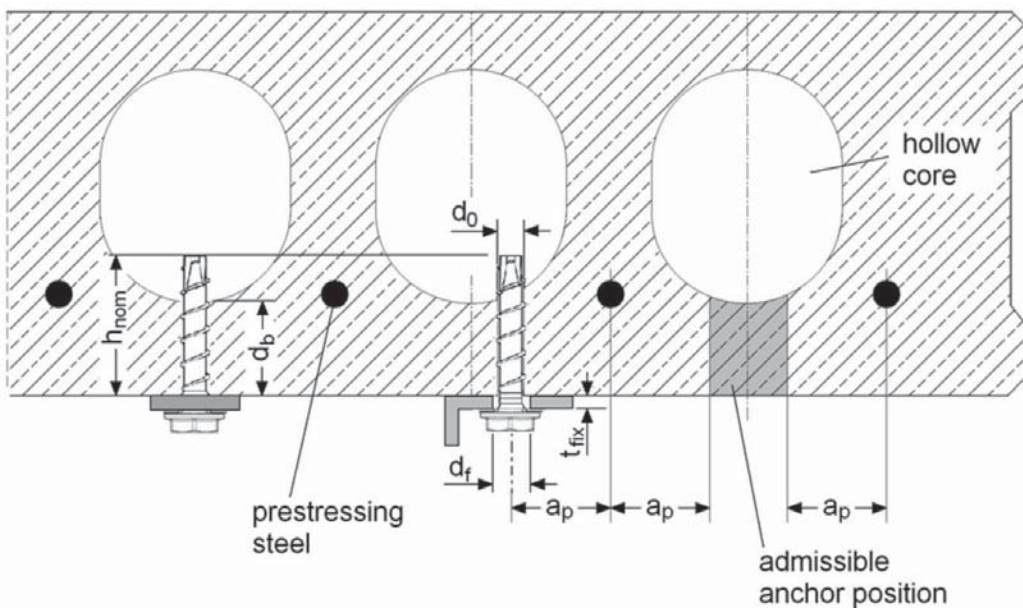

**Anchor spacing and edge distance**

Anchor size		8	10
Type	HUS3	C, H	C, H, HF
Minimum edge distance	$c_{min} \geq$ [mm]	100	
Minimum anchor spacing	$s_{min} \geq$ [mm]	100	
Minimum distance between anchor groups	$a_{min} \geq$ [mm]	100	

