

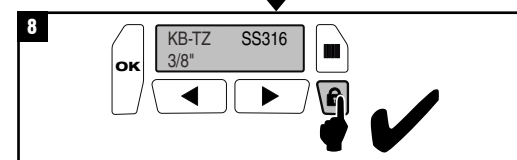

SI-AT-A22

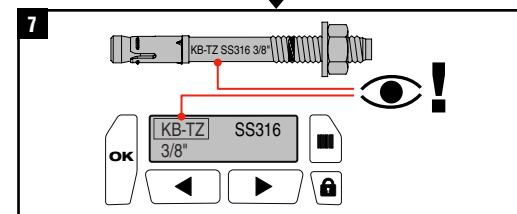

SIW 6AT-A22

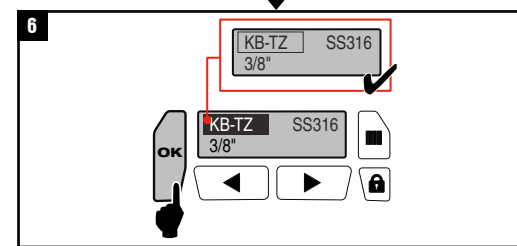
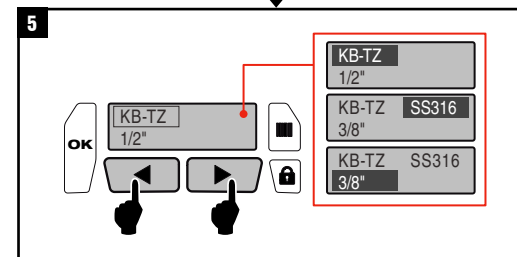
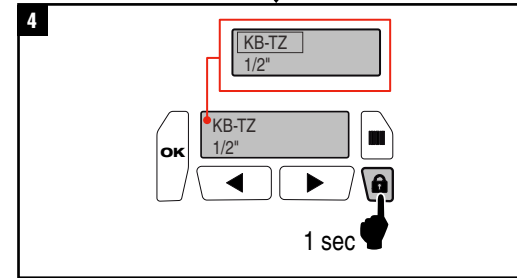
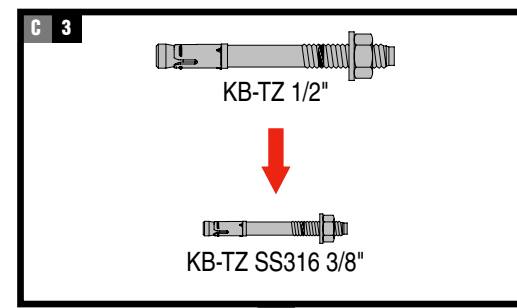
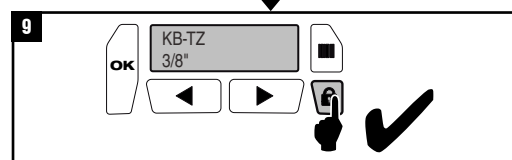
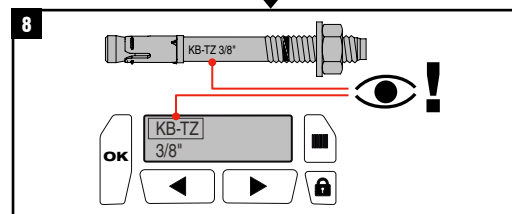
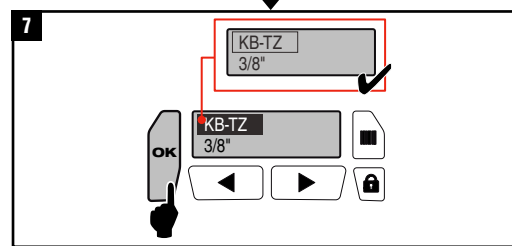
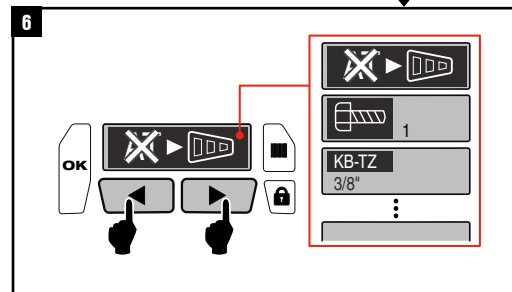
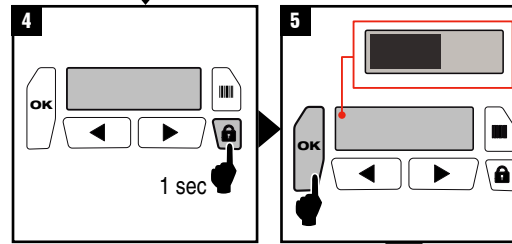
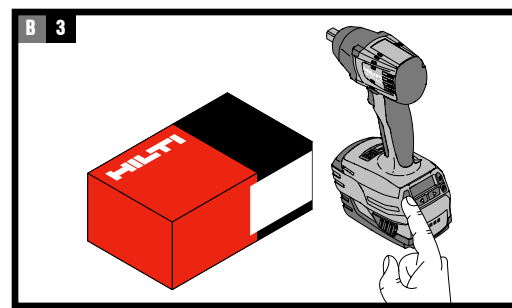
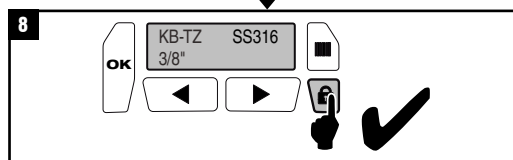
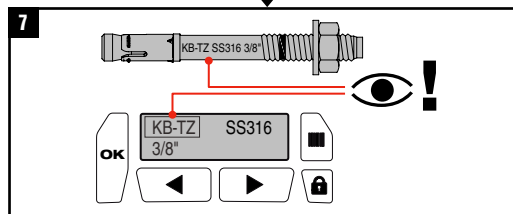
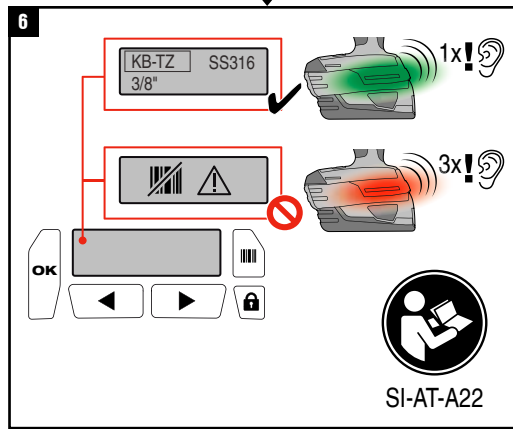
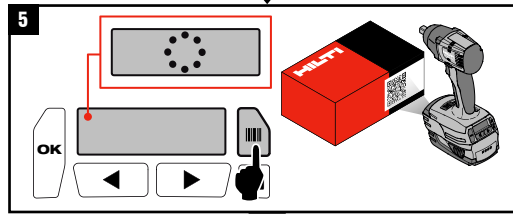
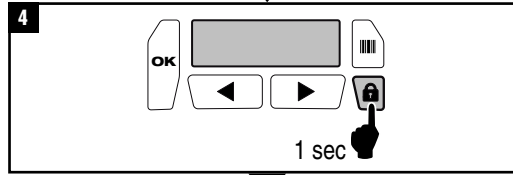
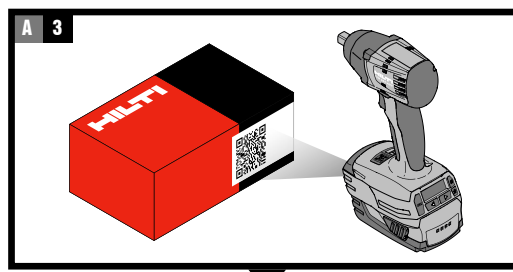
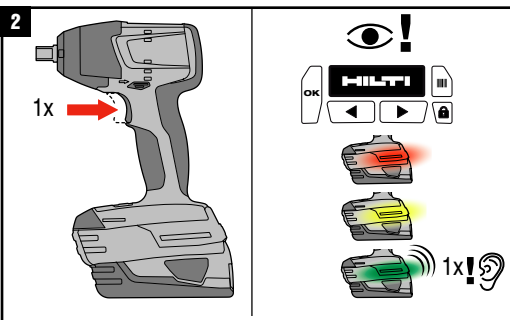
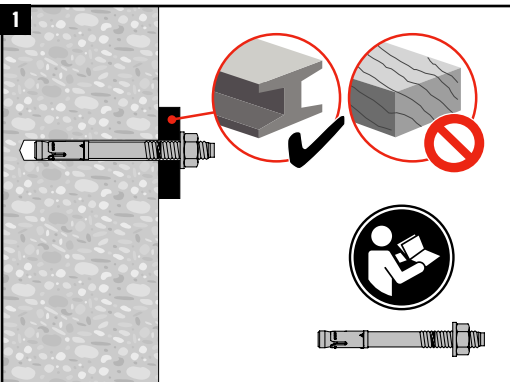

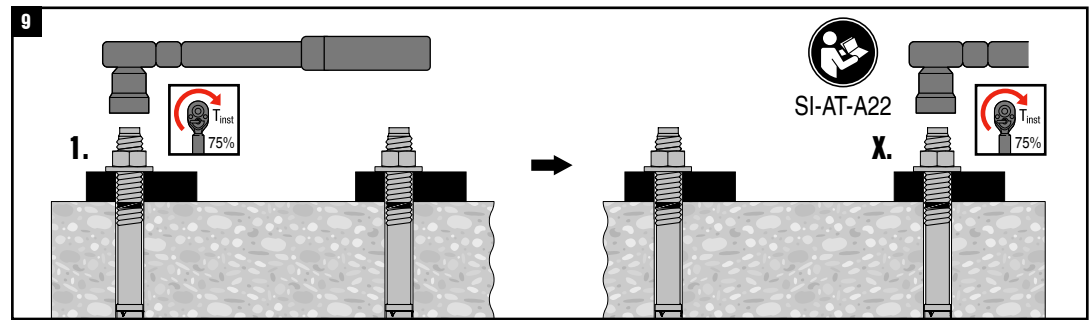
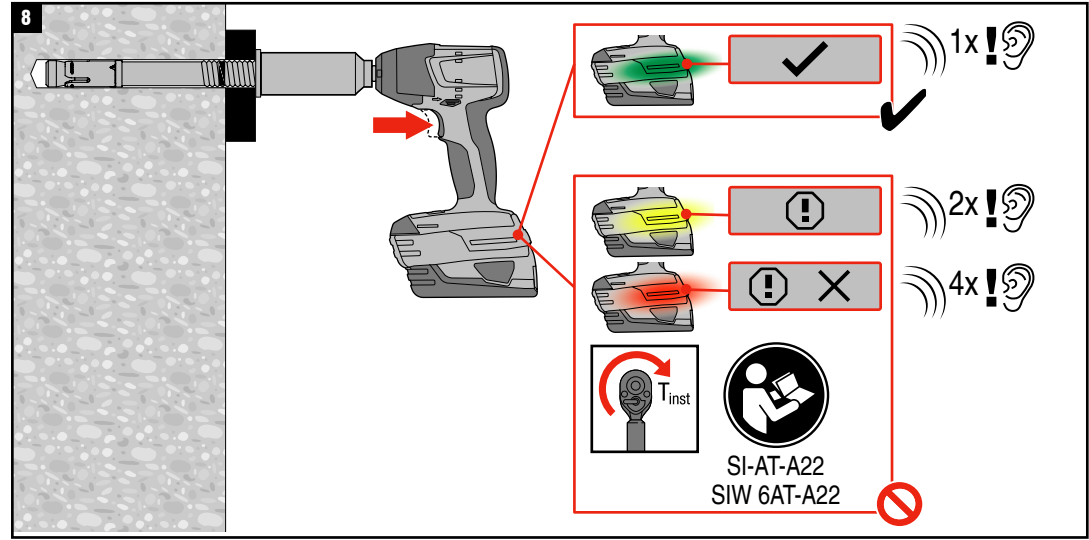
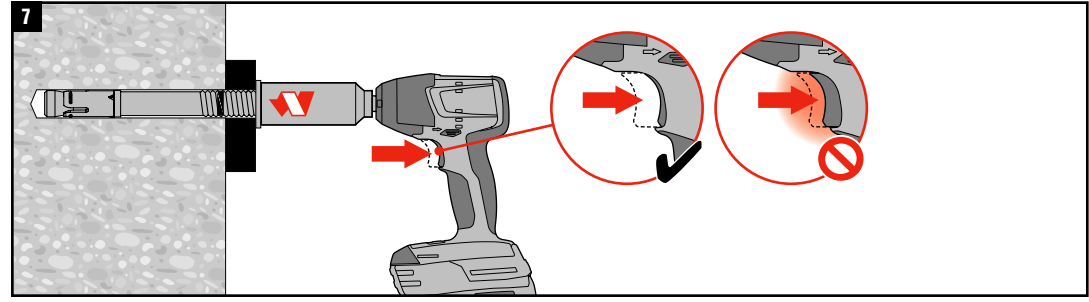
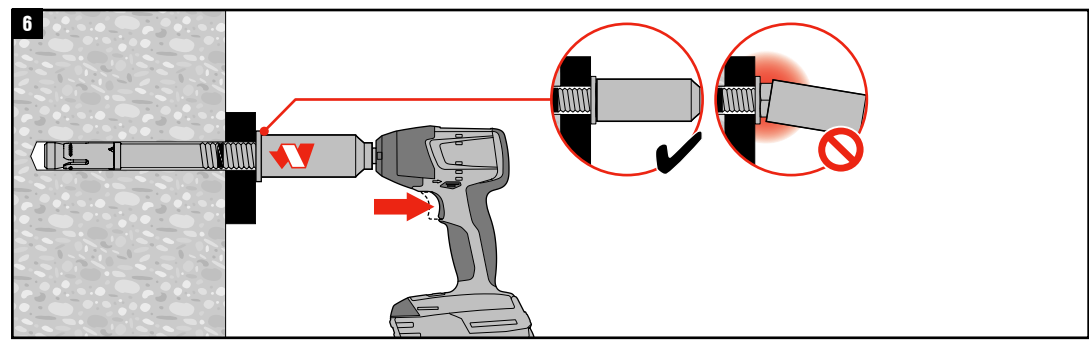
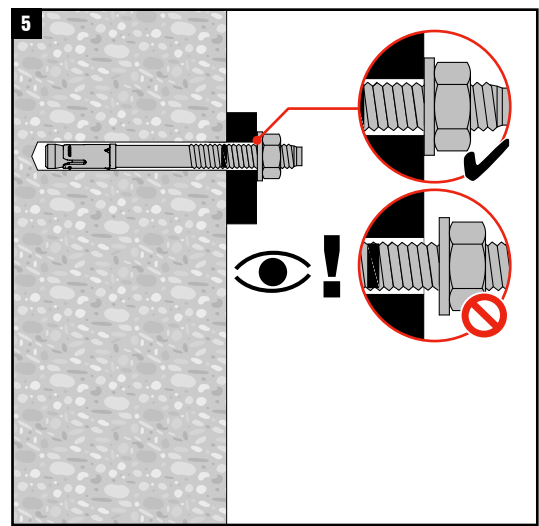
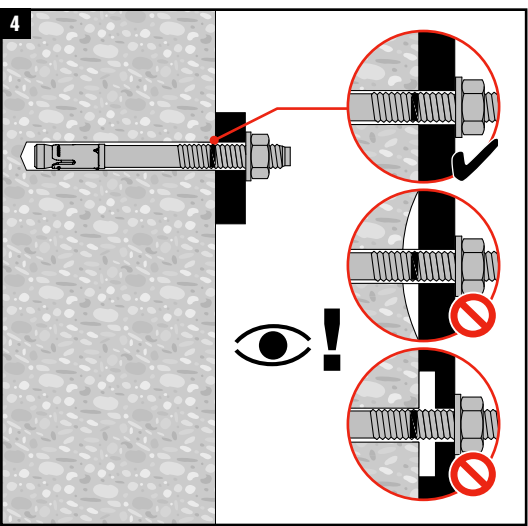
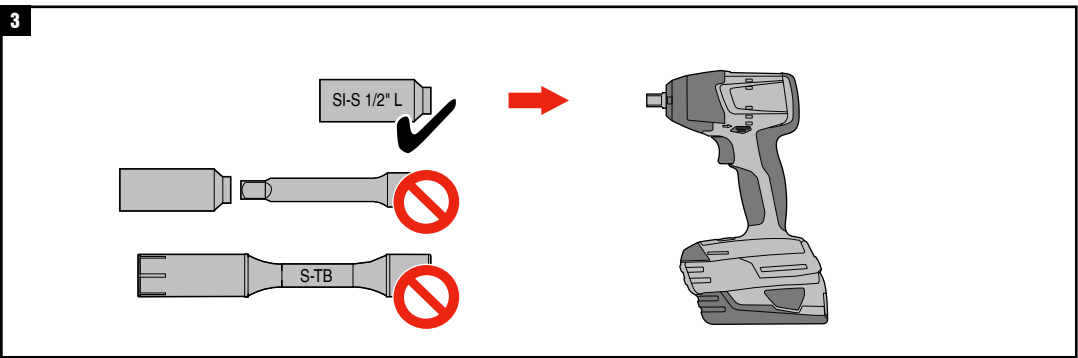
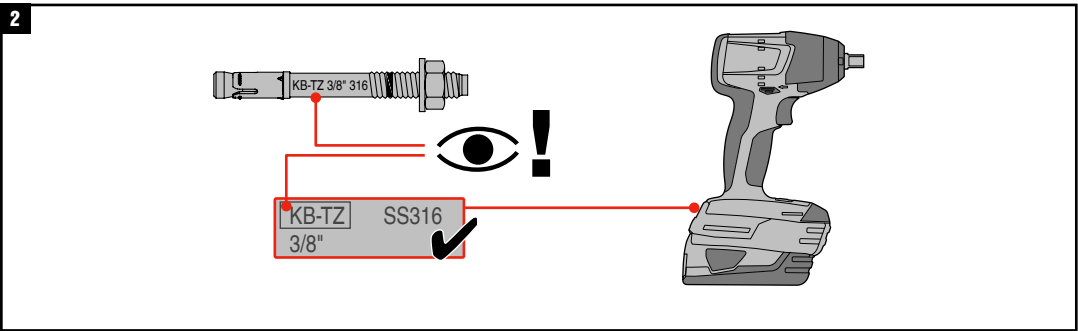
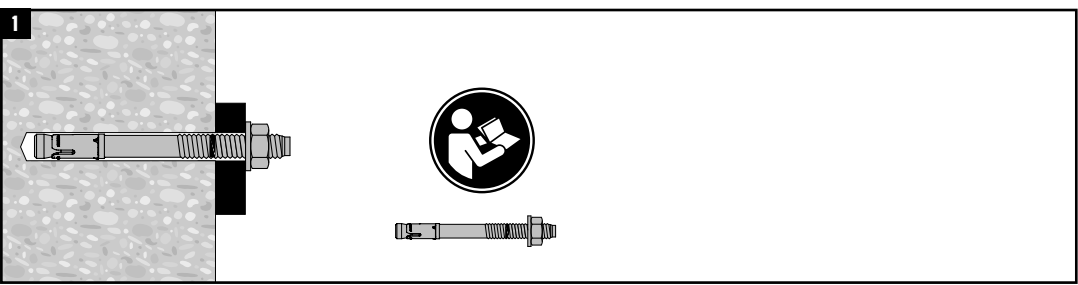



SI-AT-A22



SIW 6AT-A22

